

INFINI-P

Luminaire de signalisation plafond - Polyvalent

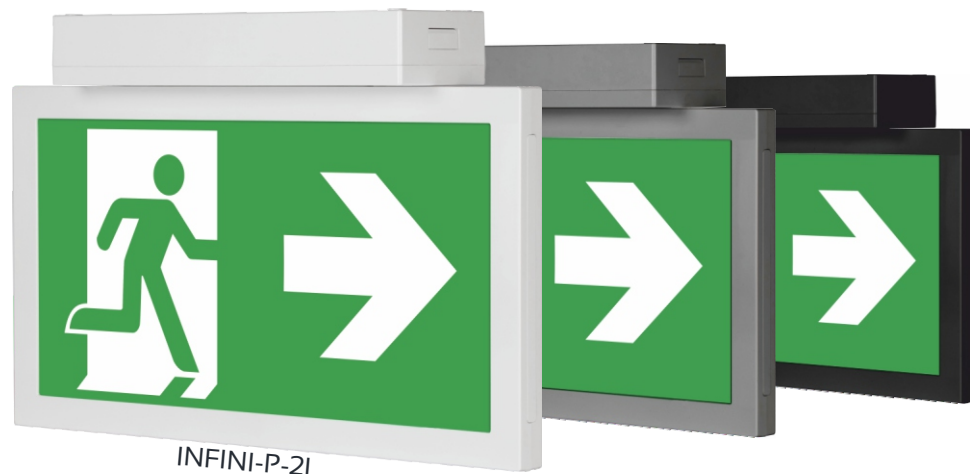

Avec boîtier
d'encastrement



Version avec éclairage
de sécurité inférieur
INFINI-P-3L+



Variante de
montage en
potence murale



Dimensions (mm)

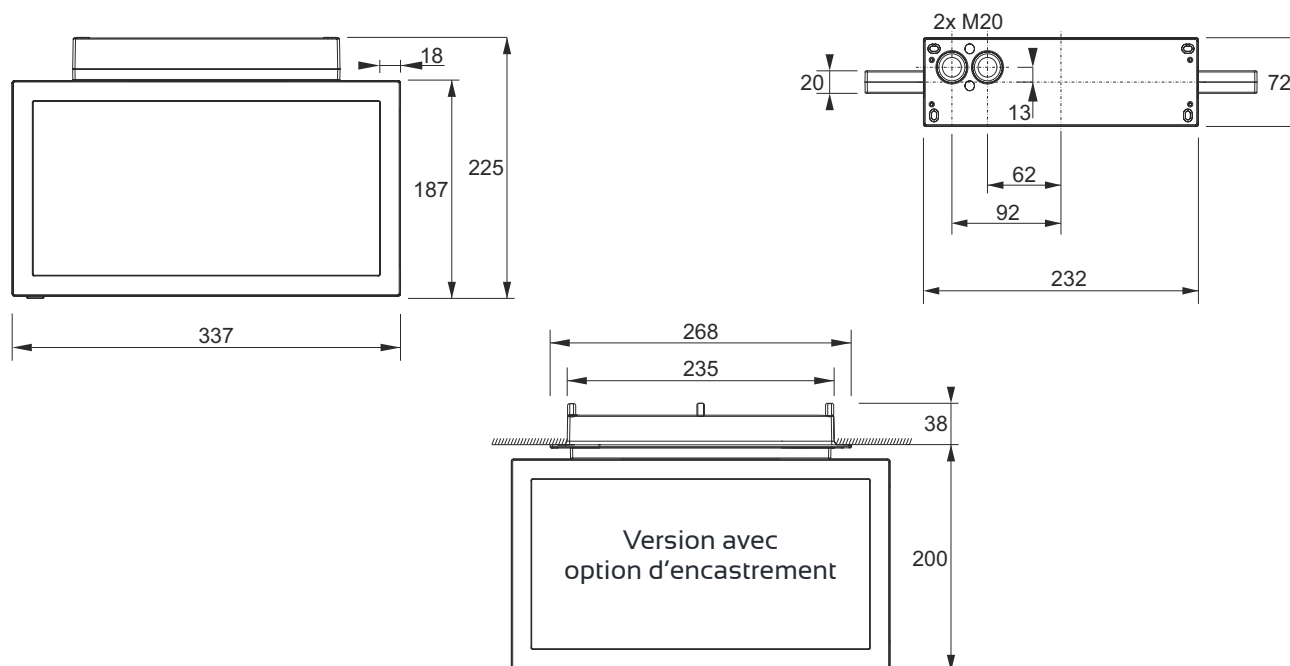

Luminaire de signalisation plafond - Polyvalent



Données techniques

Générales

| | |
|-------------------------------|---|
| Matière | Polycarbonate |
| Source lumineuse INFINI-P-2L | Strip LED 2W / 270 lm / 6000 K / > 75'000 h |
| Source lumineuse INFINI-P-3L+ | Strip LED 3W / 270 + 80 lm / 6000 K / > 75'000 h |
| Normalisation | SN-EN 1838, SN-EN 60598-2-22, SN-EN 61347-2-13, SN-EN 55015 |





Luminaire centralisés

24-48-230V

| | |
|--|---|
| Température de fonctionnement | -5 °C à 40 °C |
| Alimentation 230 V INFINI-P-2L | 230 VAC ±10% 50-60 Hz - 6 VA / 220 VDC ±20% - 3,7 W |
| Alimentation 230 V INFINI-P-3L+ | 230 VAC ±10% 50-60 Hz - 8 VA / 220 VDC ±20% - 4,8 W |
| Alimentation 24V / 48V INFINI-P-2L | 24 VDC ±20% ou 48 VDC ±20% / 3 W |
| Alimentation 24V / 48V INFINI-P-3L+ | 24 VDC ±20% ou 48 VDC ±20% / 4 W |
| SMART TECHNOLOGY  | Adressage individuel via PLC (Power line communication) |
| Poids | 1,00 kg |

Luminaire autonomes



| | |
|---|---|
| Température de fonctionnement | 0 °C à 40 °C |
| Alimentation INFINI-P-2L | 230 V ±10% 50-60 Hz - 1,9 à 8 VA max. |
| Alimentation INFINI-P-3L+ | 230 V ±10% 50-60 Hz - 1,9 à 10 VA max. |
| Chargeur / Temps de charge | PREMIUM 0,21 W / < 12 h |
| AUTOTEST  | Test automatique de la fonction et de l'autonomie |
| DALI  | Contrôle centralisé via bus DALI / Adressage individuel |
| SMART TECHNOLOGY BUS  | Contrôle centralisé via bus / Adressage individuel / Système UNA |
| SMART TECHNOLOGY WIRELESS  | Contrôle centralisé via communication sans fil / Adressage individuel / Système UNA |
| Batterie INFINI-P-2L | LiFePO ₄ 6,4 V / 1,0 Ah |
| Batterie INFINI-P-3L+ | LiFePO ₄ 6,4 V / 1,5 Ah |
| Mode secours sur batterie / Autonomie | Rendement à 100% - 1h |
| Poids | 1,10 kg |

Données photométriques

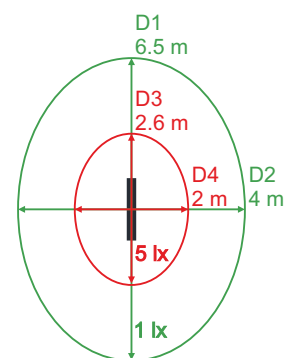
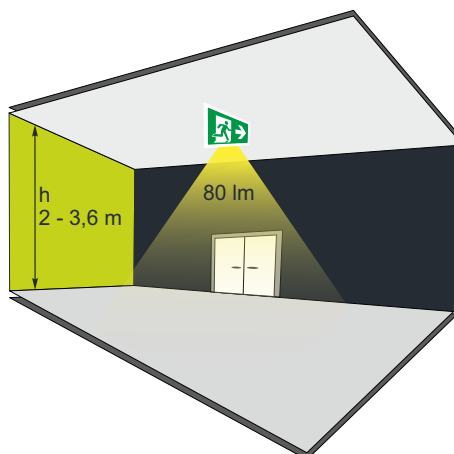
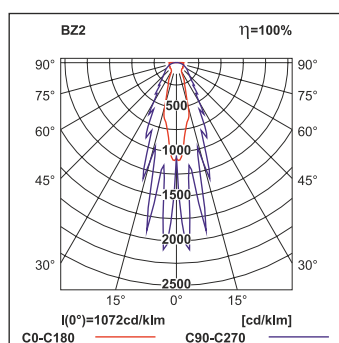

INFINI-P

Luminaire de signalisation plafond - Polyvalent



Garantie

Articles

| | Vesion | Type | N° article | Couleur |
|--|-----------------------------|---------------------|-------------|-----------------|
| INFINI-P-3L+  | | INFINI-P-3L+/ATPIL | 2106 0641 | RAL 9010 |
| | | INFINI-P-3L+/CTPIL | 2106 0641A | RAL 9010 |
| | | INFINI-P-3L+/CTWPIL | 2106 0641W | RAL 9010 |
| | | INFINI-P-3L+/DAPIL | 2106 0641D | RAL 9010 |
| | 230V^{AC/DC} | INFINI-P-3L+/230 | 2106 0642 | RAL 9010 |
| | 230V^{AC/DC} | INFINI-P-3L+/AA230 | 2106 0642AA | RAL 9010 |
| | 24V^{DC} | INFINI-P-3L+/A24 | 2106 0643 | RAL 9010 |
| | 48V^{DC} | INFINI-P-3L+/A48 | 2106 0644 | RAL 9010 |

INFINI-P-2L



| | | | |
|-----------------------------|--------------------|-------------|-----------------|
| | INFINI-P-2L/ATPIL | 2106 0645 | RAL 9010 |
| | INFINI-P-2L/CTPIL | 2106 0645A | RAL 9010 |
| | INFINI-P-2L/CTWPIL | 2106 0645W | RAL 9010 |
| | INFINI-P-2L/DAPIL | 2106 0645D | RAL 9010 |
| 230V^{AC/DC} | INFINI-P-2L/230 | 2106 0646 | RAL 9010 |
| 230V^{AC/DC} | INFINI-P-2L/AA230 | 2106 0646AA | RAL 9010 |
| 24V^{DC} | INFINI-P-2L/A24 | 2106 0647 | RAL 9010 |
| 48V^{DC} | INFINI-P-2L/A48 | 2106 0648 | RAL 9010 |

Choix de la couleur







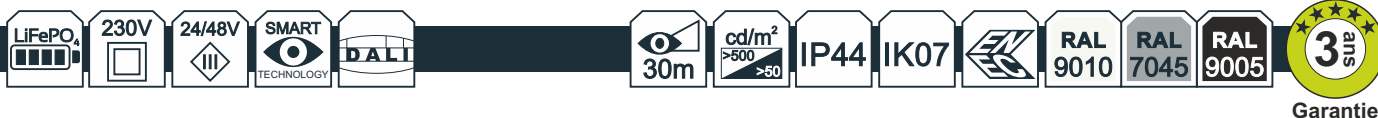



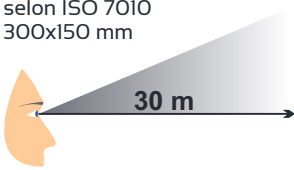
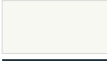







| | Type | N° article | Couleur |
|--------------|-------------------|-------------|-----------------|
| Exemple gris | INFINI-P-_L/___-G | 2106 064_-G | RAL 7045 |
| Exemple noir | INFINI-P-_L/___-N | 2106 064_-N | RAL 9005 |



Luminaire de signalisation plafond - Polyvalent



Accessoires de signalisation

| A commander séparément | Symbole | Type | N° article | Symbole | Type | N° article |
|--|---|------------------|------------|--|--|------------------|
| Films pictogrammes selon ISO 7010 300x150 mm  |  | PICF-INFINI-V.2 | 2106 0690 |  | PICF-INFINI-NW | 2106 0709 |
| |  | PICF-INFINI-B.1 | 2106 0691 |  | PICF-INFINI-E.2 | 2106 0711 |
| |  | PICF-INFINI-H.1 | 2106 0693 |  | PICF-INFINI-T.2 | 2106 0712 |
| |  | PICF-INFINI-G.1 | 2106 0695 |  | PICF-INFINI-ET.2 | 2106 0721 |
| |  | PICF-INFINI-D.1 | 2106 0697 |  | PICF-INFINI-PP.2 | 2106 0729 |
| |  | PICF-INFINI-GH.1 | 2106 0701 |  | PICF-INFINI-EP.2 | 2106 0731 |
| |  | PICF-INFINI-GB.1 | 2106 0703 |  | PICF-INFINI-BV.2 | 2106 0741 |
| |  | PICF-INFINI-DH.1 | 2106 0705 |  | PICF-INFINI-HV.2 | 2106 0742 |
| |  | PICF-INFINI-DB.1 | 2106 0707 |  | PICF-INFINI-GV.2 | 2106 0743 |
| | | | | |  | PICF-INFINI-DV.2 |

Accessoires d'encastrement

Boîtier d'encastrement pour faux-plafond

Matière : polycarbonate
 Entrée tube : 2x M20
 Montage : 2x ressorts latéraux

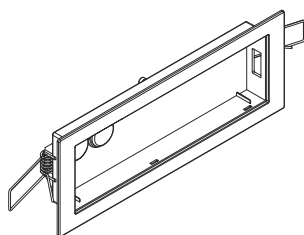

| Type | N° article | Couleur |
|-----------------------------------|-------------|---|
| BE-INFINI | 2106 0681 | RAL 9010 |
| BE-INFINI-G | 2106 0681-G | RAL 7045 |
| BE-INFINI-N | 2106 0681-N | RAL 9005 |
| Découpe d'insertion : 240 x 80 mm | |  |
| Vide d'insertion : 95 mm minimum | | |

Boîtier d'encastrement pour mur en brique ou béton

Matière : inox
 Entrée tube : 2x M20
 Montage : clous ou scellement
 Dimensions : 256 x 76 x 41 mm

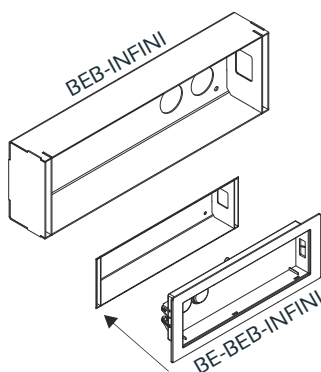

| Type | N° article | Couleur |
|-----------------|-------------|-----------------|
| BEB-INFINI | 2106 0682 | INOX |
| BE-BEB-INFINI-B | 2106 0682-B | RAL 9010 |
| BE-BEB-INFINI-G | 2106 0682-G | RAL 7045 |
| BE-BEB-INFINI-N | 2106 0682-N | RAL 9005 |