

# SPOT L3-C

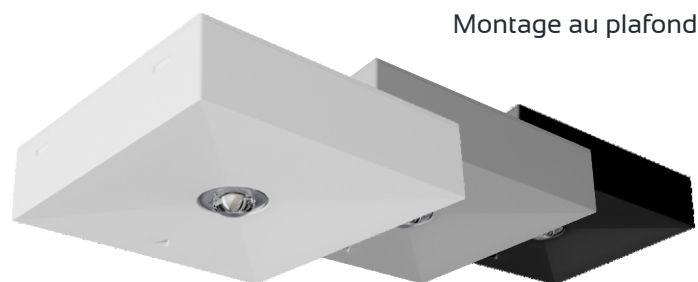

Garantie



Montage au plafond

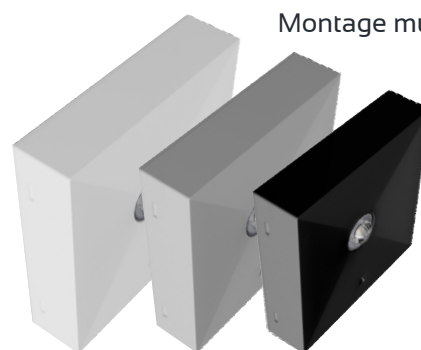

Montage mural

**L3U-C**  
Lentille symétrique  
«Universelle»

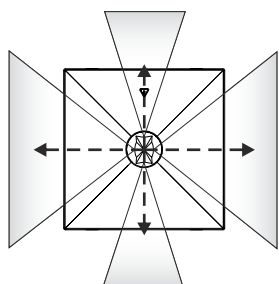

**L3R-C**  
Lentille asymétrique  
«Voie de fuite»

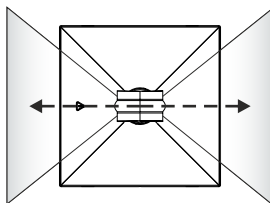
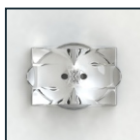

**L3A-C**  
Lentille asymétrique  
«Voie de fuite»

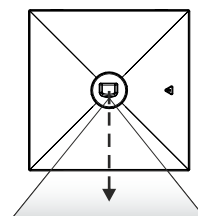

Avec base rehaussée pour un câblage apparent (Accessoire GB-L3\_C)



Avec cadre d'encastement pour faux plafond ou paroi creuse (Accessoire CE-L3-C)



## Dimensions (mm)

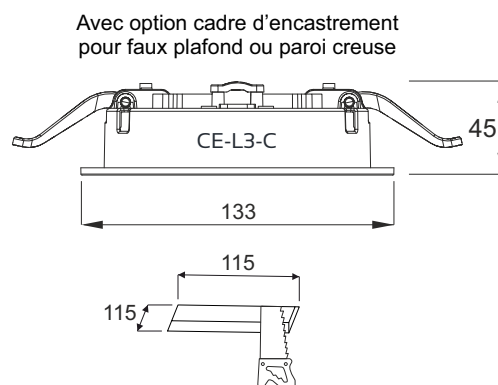
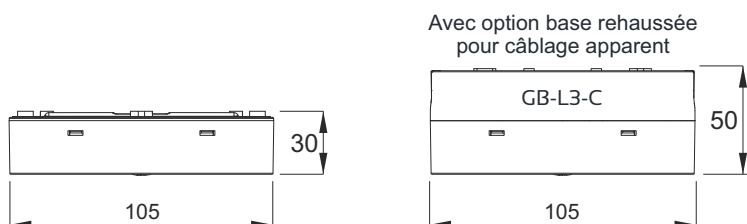

# SPOT L3-C

## Luminaire de sécurité carré - Montage apparent



Garantie

### Données techniques

#### Générales

Matière	Polycarbonate
Source lumineuse	LED 2W / 380 lm / 6000 K / > 75'000 h
Normalisation	SN-EN 1838, SN-EN 60598-2-22, SN-EN 61347-2-13, SN-EN 55015

#### Luminaire centralisés

24-48-230V

Température de fonctionnement	0 °C à 50 °C
Alimentation 230 V	230 VAC ±10% 50-60 Hz - 4,4 VA / 220 VDC ±20% - 2,4 W
Alimentation TBTS 24V / 48V	24 VDC ±20% ou 48 VDC ±20% / 3,2 W
SMART TECHNOLOGY	Adressage individuel via PLC (Power line communication)
Poids	0,110 kg

#### Luminaire autonomes



Température de fonctionnement	0 °C à 40 °C
Alimentation	230 V ±10% 50-60 Hz - 2 à 9,2 VA max.
Chargeur / Temps de charge	PREMIUM 0,65 W / < 12 h
AUTOTEST	Test automatique de la fonction et de l'autonomie
DALI	Contrôle centralisé via bus DALI / Adressage individuel
SMART TECHNOLOGY BUS	Contrôle centralisé via bus / Adressage individuel / Système UNA
SMART TECHNOLOGY WIRELESS	Contrôle centralisé via communication sans fil / Adressage individuel / Système UNA
Batterie / Autonomie	LiFePO <sub>4</sub> 3,2 V / 1,0 Ah - 1 heure
Poids	0,160 kg

### Accessoires

#### Base rehaussée pour un câblage apparent

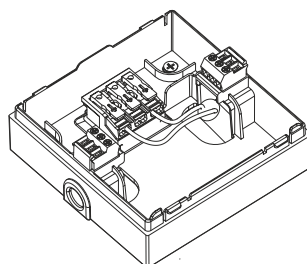

Type	N° article	Couleur
GB-L3-C	2106 0559	<b>RAL 9003</b>
GB-L3-C	2106 0559-G	<b>RAL 7045</b>
GB-L3-C	2106 0559-N	<b>RAL 9005</b>

Matière : polycarbonate  
Montage : 2x pattes latérales, serrage à vis

#### Cadre d'encastrement pour faux-plafond ou paroi creuse

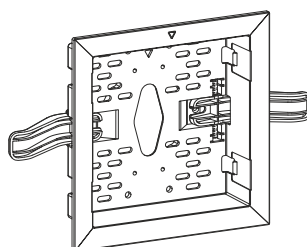

Type	N° article	Couleur
CE-L3-C	2106 0558	<b>RAL 9003</b>
CE-L3-C	2106 0558-G	<b>RAL 7045</b>
CE-L3-C	2106 0558-N	<b>RAL 9005</b>

Matière : polycarbonate  
Montage : 2x pattes latérales, serrage à vis  
Ouverture d'encastrement : 115x115 mm  
Vide d'insertion : 50 mm minimum

# SPOT L3-C

## Luminaire de sécurité carré - Montage apparent



Garantie

### Articles

	Vesion	Type	N° article	Couleur
<b>L3U-C</b>  Montage au plafond Lentille symétrique «Universelle»		L3U-C-2L/ATPIL	2106 0541	<b>RAL 9003</b>
		L3U-C-2L/CTPIL	2106 0541A	<b>RAL 9003</b>
		L3U-C-2L/CTWPIL	2106 0541W	<b>RAL 9003</b>
		L3U-C-2L/DAPIL	2106 0541D	<b>RAL 9003</b>
	<b>230V<sup>AC/DC</sup></b>	L3U-C-2L/AA230	2106 0542AA	<b>RAL 9003</b>
	<b>24V<sup>DC</sup></b>	L3U-C-2L/A24	2106 0543	<b>RAL 9003</b>
	<b>48V<sup>DC</sup></b>	L3U-C-2L/A48	2106 0544	<b>RAL 9003</b>

<b>L3R-C</b>  Montage au plafond Lentille asymétrique «Voie de fuite»		L3R-C-2L/ATPIL	2106 0545	<b>RAL 9003</b>
		L3R-C-2L/CTPIL	2106 0545A	<b>RAL 9003</b>
		L3R-C-2L/CTWPIL	2106 0545W	<b>RAL 9003</b>
		L3R-C-2L/DAPIL	2106 0545D	<b>RAL 9003</b>
	<b>230V<sup>AC/DC</sup></b>	L3R-C-2L/AA230	2106 0546AA	<b>RAL 9003</b>
	<b>24V<sup>DC</sup></b>	L3R-C-2L/A24	2106 0547	<b>RAL 9003</b>
	<b>48V<sup>DC</sup></b>	L3R-C-2L/A48	2106 0548	<b>RAL 9003</b>

<b>L3A-C</b>  Montage mural Lentille asymétrique «Voie de fuite»		L3A-C-2L/ATPIL	2106 0551	<b>RAL 9003</b>
		L3A-C-2L/CTPIL	2106 0551A	<b>RAL 9003</b>
		L3A-C-2L/CTWPIL	2106 0551W	<b>RAL 9003</b>
		L3A-C-2L/DAPIL	2106 0551D	<b>RAL 9003</b>
	<b>230V<sup>AC/DC</sup></b>	L3A-C-2L/AA230	2106 0552AA	<b>RAL 9003</b>
	<b>24V<sup>DC</sup></b>	L3A-C-2L/A24	2106 0553	<b>RAL 9003</b>
	<b>48V<sup>DC</sup></b>	L3A-C-2L/A48	2106 0554	<b>RAL 9003</b>

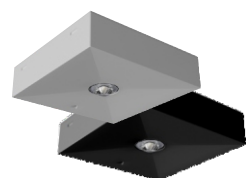

Choix de la couleur	Type	N° article	Couleur
Exemple gris	L3_-C-2L/___-G	2106 05__-G	<b>RAL 7045</b>
Exemple noir	L3_-C-2L/___-N	2106 05__-N	<b>RAL 9005</b>

# SPOT L3-C

## Luminaire de sécurité carré - Montage apparent



Garantie

### Données photométriques

#### L3U 2W 380 lm Montage plafond - optique symétrique

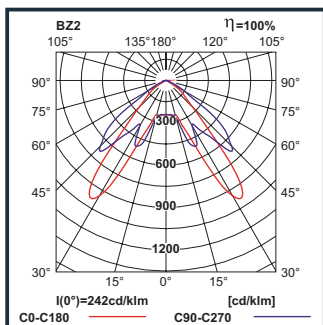

Voie de fuite - 1 lx					
h	X1	X2	Y1	Y2	
2,5	4,0	10,0	3,5	9,0	
3,0	4,5	11,0	4,0	10,0	
3,5	5,0	12,0	4,5	11,0	
4,0	5,5	13,0	5,0	12,0	
4,5	6,0	14,0	5,5	13,0	
5,0	6,5	15,0	6,0	14,0	
6,0	7,0	16,0	6,5	15,0	
7,0	6,0	14,0	6,0	14,0	
8,0	4,0	12,0	5,5	13,0	

Zone anti-panique - 0,5 lx					
h	X1	X2	Y1	Y2	
2,5	4,5	11,0	4,0	10,0	
3,0	5,0	12,0	4,5	11,0	
3,5	5,5	13,0	5,0	12,0	
4,0	6,0	14,0	5,5	13,0	
4,5	6,5	15,0	6,0	14,0	
5,0	7,0	16,0	6,5	15,0	
6,0	7,5	17,0	7,0	16,0	
7,0	8,0	18,0	7,5	17,0	
8,0	7,5	17,0	7,0	16,0	

Equipement sécurisé - 5 lx					
h	X1	X2	Y1	Y2	
2,5	3,0	7,0	2,5	6,0	
3,0	3,0	7,5	2,5	6,5	
3,5	2,5	7,5	2,0	6,5	
4,0	2,0	7,0	1,5	6,0	

#### L3R 2W 380lm Montage plafond - optique asymétrique

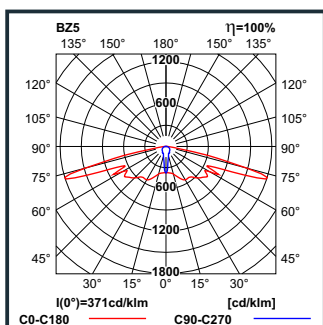

Voie de fuite - 1 lx					
h	X1	X2	Y1	Y2	
2,5	9,5	22,0	2,0	5,0	
3,0	10,5	23,0	2,0	5,0	
3,5	11,5	24,0	2,0	5,0	
4,0	12,5	25,0	1,5	4,5	
4,5	11,5	26,0	1,5	4,5	
5,0	10,5	27,0	1,5	4,0	
6,0	9,5	25,0	1,5	4,0	

Zone anti-panique - 0,5 lx					
h	X1	X2	Y1	Y2	
2,5	10,5	24,0	2,5	6,0	
3,0	11,5	25,0	2,5	6,0	
3,5	12,5	26,0	2,5	6,0	
4,0	13,5	27,0	2,5	6,0	
4,5	13,5	28,0	2,5	6,0	
5,0	12,5	29,0	2,0	5,5	
6,0	11,5	29,0	2,0	5,5	

Equipement sécurisé - 5 lx					
h	X1	X2	Y1	Y2	
2,5	4,0	10,0	1,0	2,0	
3,0	4,0	9,5	1,0	2,0	
3,5	4,0	9,0	1,0	2,0	
4,0	3,5	9,0	1,0	2,0	

#### L3A 2W 380lm Montage mural - optique asymétrique

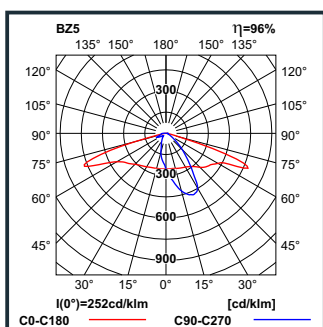

Voie de fuite - 1 lx				
h	Z1	Z2	Z3	
2,5	6,5	17,0	2,5	
3,0	7,5	18,0	3,0	
3,5	7,5	19,0	3,0	
4,0	7,0	20,0	3,5	
4,5	7,0	21,0	3,5	
5,0	6,5	20,0	3,5	
6,0	6,5	19,0	3,5	

Zone anti-panique - 0,5 lx				
h	Z1	Z2	Z3	
2,5	7,0	18,0	3,0	
3,0	8,0	19,0	3,5	
3,5	8,0	20,0	3,5	
4,0	8,0	21,0	4,0	
4,5	7,5	22,0	4,0	
5,0	7,5	21,0	4,0	
6,0	7,0	20,0	4,0	

Equipement sécurisé - 5 lx				
h	Z1	Z2	Z3	
2,5	2,5	7,0	2,0	
3,0	3,0	7,0	2,5	
3,5	3,0	7,0	2,5	
4,0	2,5	6,5	2,0	

