

# INFINI-M

## Rettungszeichenleuchte Wand - multifunktionell

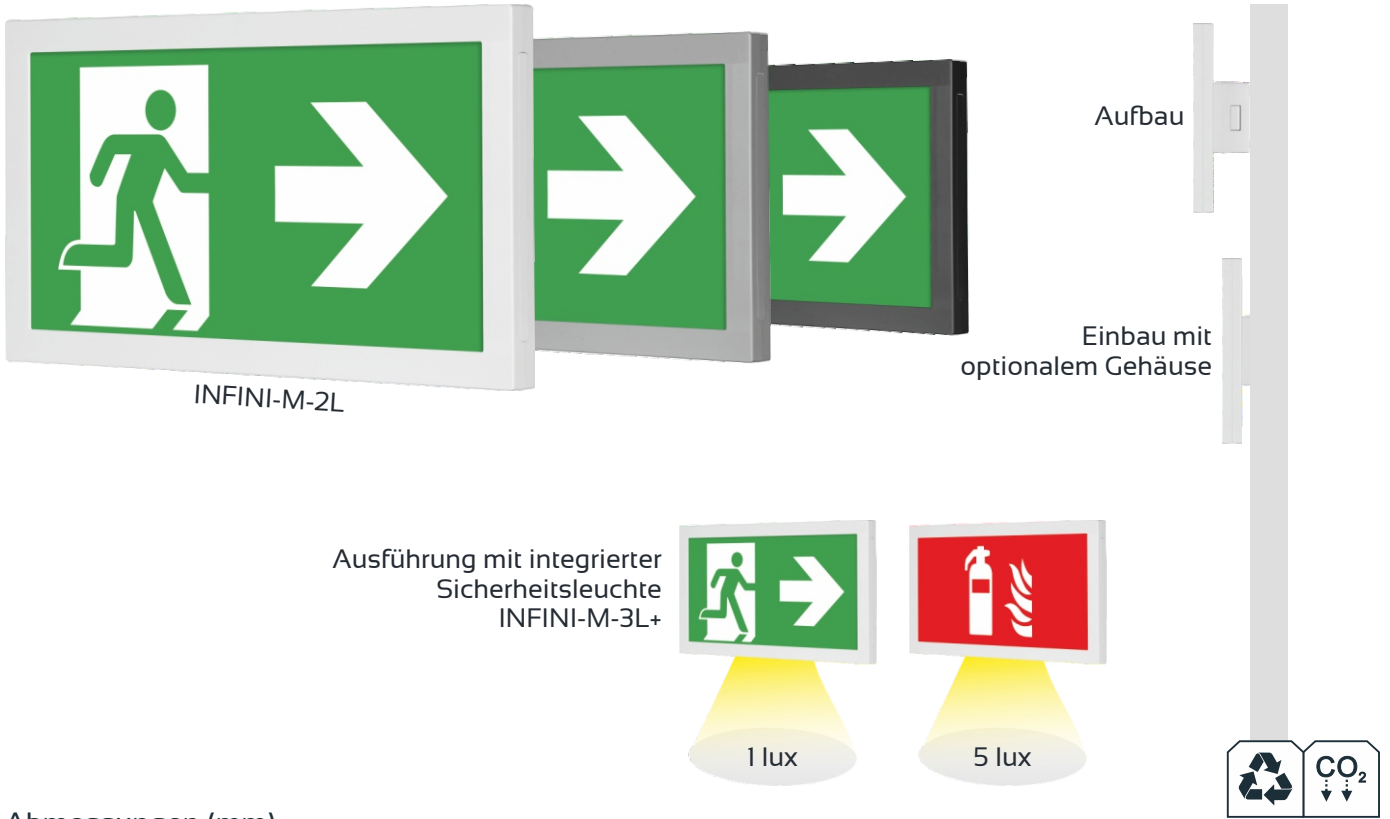

Garantie



Abmessungen (mm)

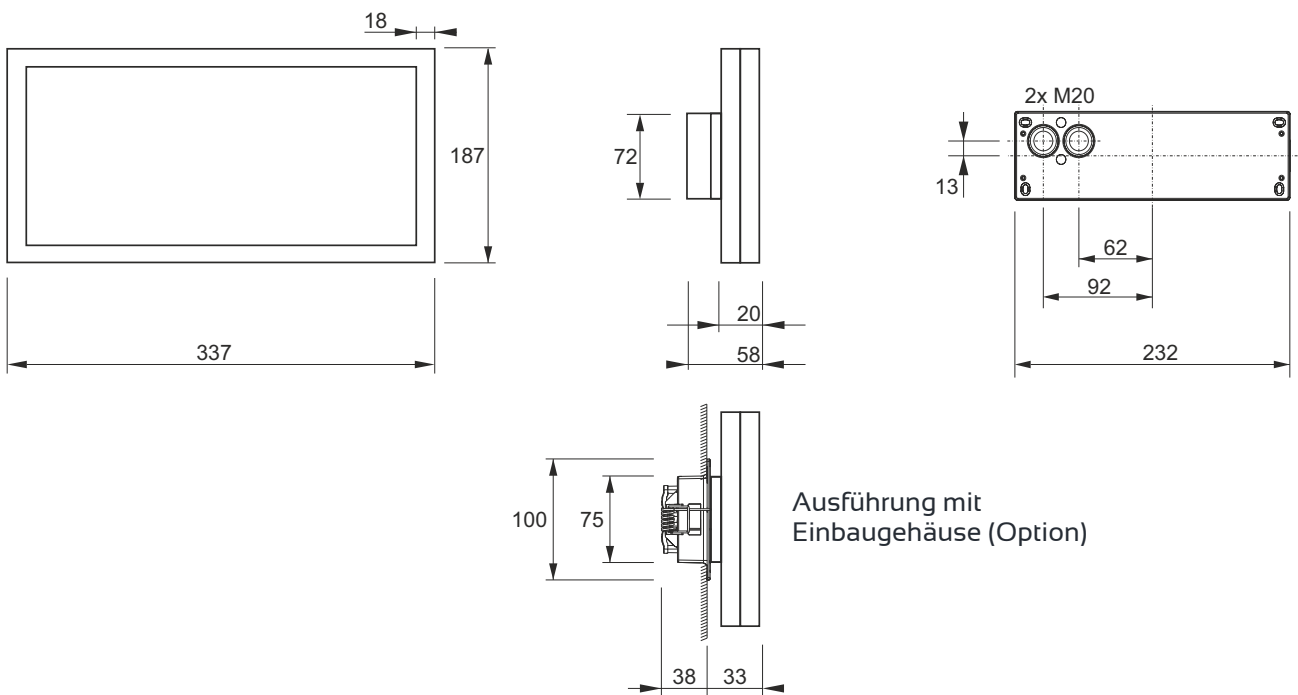

Ausführung mit Einbaugehäuse (Option)

## Rettungszeichenleuchte Wand - multifunktionell

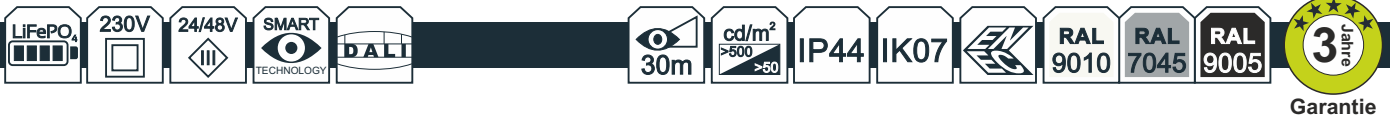

### Technische Daten

#### Allgemein

|                           |   |
|---------------------------|---|
| Material                  | Polycarbonat  |
| Leuchtmittel INFINI-M-2L  | LED Steifen 2W / 270 lm / 6000 K / > 75'000 h               |
| Leuchtmittel INFINI-M-3L+ | LED Steifen 3W / 270 + 80 lm / 6000 K / > 75'000 h          |
| Normen                    | SN-EN 1838, SN-EN 60598-2-22, SN-EN 61347-2-13, SN-EN 55015 |





#### Leuchten Zentralbatterie

24-48-230V

|  |   |
|--|---|
| Temperaturbereich  | -5 °C bis 40 °C                                     |
| Spannung 230 V INFINI-M-2L   | 230 VAC ±10% 50-60 Hz - 6 VA / 220 VDC ±20% - 3,7 W |
| Spannung 230 V INFINI-M-3L+  | 230 VAC ±10% 50-60 Hz - 8 VA / 220 VDC ±20% - 4,8 W |
| Spannung 24V / 48V INFINI-M-2L   | 24 VDC ±20% ou 48 VDC ±20% / 3 W                    |
| Spannung 24V / 48V INFINI-M-3L+  | 24 VDC ±20% ou 48 VDC ±20% / 4 W                    |
| SMART TECHNOLOGY  | Adressierbar via PLC (Power line communication)     |
| Gewicht  | 1,00 kg   |

#### Autonome Leuchten



|   |  |
|---|--|
| Temperaturbereich   | 0 °C bis 40 °C   |
| Spannung INFINI-M-2L  | 230 V ±10% 50-60 Hz - 1,9 à 8 VA max.                                      |
| Spannung INFINI-M-3L+   | 230 V ±10% 50-60 Hz - 1,9 à 10 VA max.                                     |
| Ladeteil / Ladezeit   | PREMIUM 0,21 W / < 12 h  |
| AUTOTEST                   | Selbsttest Funktion und Autonomie  |
| DALI                       | Zentralisierte Kontrolle via DALI BUS / Einzelleuchtenadressierung         |
| SMART TECHNOLOGY BUS       | Zentralisierte Kontrolle via BUS / Einzelleuchtenadressierung / System UNA |
| SMART TECHNOLOGY WIRELESS  | Zentralisierte Kontrolle via Funk/ Einzelleuchtenadressierung / System UNA |
| Batterie INFINI-M-2L  | LiFePO <sub>4</sub> 6,4 V / 1,0 Ah   |
| Batterie INFINI-M-3L+   | LiFePO <sub>4</sub> 6,4 V / 1,5 Ah   |
| Lichtstromfaktor Not / Autonomie  | 100% - 1h  |
| Gewicht   | 1,10 kg  |

### Fotometrische Daten

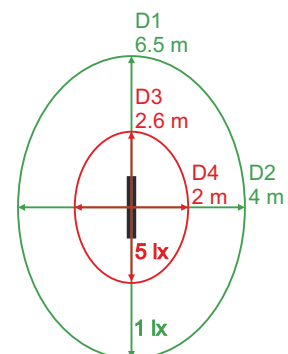
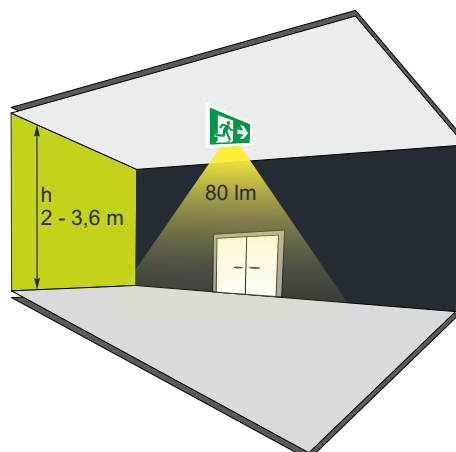
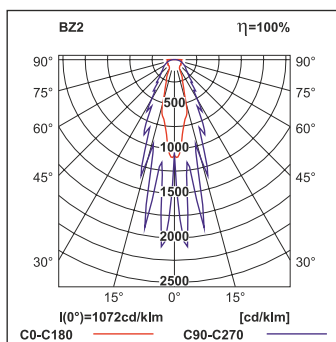









# INFINI-M

## Rettungszeichenleuchte Wand - multifunktionell







Garantie

### Artikel

|  | Version  | Typ                 | Artikel Nr. | Farbe           |
|--|--|---------------------|-------------|-----------------|
| <b>INFINI-M-3L+</b><br> |  AT                             | INFINI-M-3L+/ATPIL  | 2106 0631   | <b>RAL 9010</b> |
|  |  CT                             | INFINI-M-3L+/CTPIL  | 2106 0631A  | <b>RAL 9010</b> |
|  |  CTW                            | INFINI-M-3L+/CTWPIL | 2106 0631W  | <b>RAL 9010</b> |
|  |  DALI                           | INFINI-M-3L+/DAPIL  | 2106 0631D  | <b>RAL 9010</b> |
|  | <b>230V<sup>AC/DC</sup></b>  | INFINI-M-3L+/230    | 2106 0632   | <b>RAL 9010</b> |
|  | <b>230V<sup>AC/DC</sup></b>  AA | INFINI-M-3L+/AA230  | 2106 0632AA | <b>RAL 9010</b> |
|  | <b>24V<sup>DC</sup></b>  A      | INFINI-M-3L+/A24    | 2106 0633   | <b>RAL 9010</b> |
|  | <b>48V<sup>DC</sup></b>  A      | INFINI-M-3L+/A48    | 2106 0634   | <b>RAL 9010</b> |

### INFINI-M-2L



|  |                    |             |                 |
|--|--------------------|-------------|-----------------|
|  AT                             | INFINI-M-2L/ATPIL  | 2106 0635   | <b>RAL 9010</b> |
|  CT                             | INFINI-M-2L/CTPIL  | 2106 0635A  | <b>RAL 9010</b> |
|  CTW                            | INFINI-M-2L/CTWPIL | 2106 0635W  | <b>RAL 9010</b> |
|  DALI                           | INFINI-M-2L/DAPIL  | 2106 0635D  | <b>RAL 9010</b> |
| <b>230V<sup>AC/DC</sup></b>  | INFINI-M-2L/230    | 2106 0636   | <b>RAL 9010</b> |
| <b>230V<sup>AC/DC</sup></b>  AA | INFINI-M-2L/AA230  | 2106 0636AA | <b>RAL 9010</b> |
| <b>24V<sup>DC</sup></b>  A      | INFINI-M-2L/A24    | 2106 0637   | <b>RAL 9010</b> |
| <b>48V<sup>DC</sup></b>  A      | INFINI-M-2L/A48    | 2106 0638   | <b>RAL 9010</b> |

#### Auswahl Farbe

|                  | Typ                 | Artikel Nr. | Farbe           |
|------------------|---------------------|-------------|-----------------|
| Beispiel Grau    | INFINI-M-_L/_ ___-G | 2106 063_-G | <b>RAL 7045</b> |
| Beispiel Schwarz | INFINI-M-_L/_ ___-N | 2106 063_-N | <b>RAL 9005</b> |

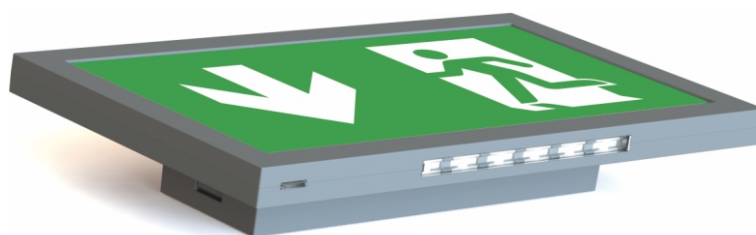

# INFINI-M

## Rettungszeichenleuchte Wand - multifunktionell









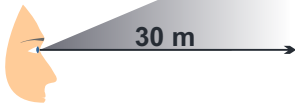

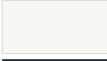









### Zubehör Signalisation

Separat zu bestellen

Piktogramme  
gemäss ISO 7010  
300x150 mm



| Symbole   | Typ              | Artikel Nr. | Symbole  | Typ              | Artikel Nr. |
|---|------------------|-------------|--|------------------|-------------|
|    | PICF-INFINI-V.2  | 2106 0690   |    | PICF-INFINI-NW   | 2106 0709   |
|    | PICF-INFINI-B.1  | 2106 0691   |    | PICF-INFINI-E.2  | 2106 0711   |
|    | PICF-INFINI-H.1  | 2106 0693   |    | PICF-INFINI-T.2  | 2106 0712   |
|    | PICF-INFINI-G.1  | 2106 0695   |    | PICF-INFINI-ET.2 | 2106 0721   |
|    | PICF-INFINI-D.1  | 2106 0697   |    | PICF-INFINI-PP.2 | 2106 0729   |
|   | PICF-INFINI-GH.1 | 2106 0701   |   | PICF-INFINI-EP.2 | 2106 0731   |
|  | PICF-INFINI-GB.1 | 2106 0703   |  | PICF-INFINI-BV.2 | 2106 0741   |
|  | PICF-INFINI-DH.1 | 2106 0705   |  | PICF-INFINI-HV.2 | 2106 0742   |
|  | PICF-INFINI-DB.1 | 2106 0707   |  | PICF-INFINI-GV.2 | 2106 0743   |
|   |                  |             |  | PICF-INFINI-DV.2 | 2106 0744   |

### Zubehör Einbau

Einbaugehäuse  
Hohldecke / Wand

Material: Polycarbonat  
Kalbeinführung Rohr : 2x M20  
Montage : 2x Spannfedern

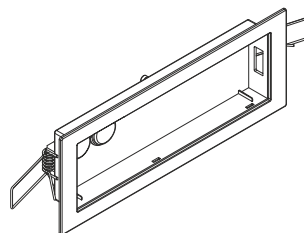

| Typ                         | Artikel Nr. | Farbe   |
|-----------------------------|-------------|---|
| BE-INFINI                   | 2106 0681   | <b>RAL 9010</b>   |
| BE-INFINI-G                 | 2106 0681-G | <b>RAL 7045</b>   |
| BE-INFINI-N                 | 2106 0681-N | <b>RAL 9005</b>   |
| Ausschnitt : 240 x 80 mm    |             |  |
| Einbautiefe : 95 mm minimum |             |   |

Betoneingiessgehäuse

Material : Inox  
Kalbeinführung Rohr : 2x M20  
Montage : Nägel oder vergossen  
Abmessungen : 256 x 76 x 41 mm

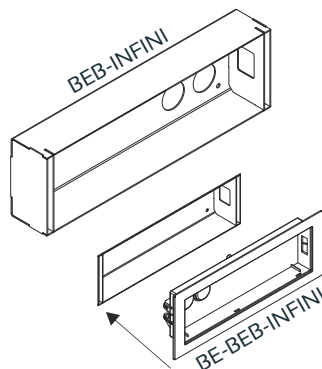

| Typ             | Artikel Nr. | Farbe           |
|-----------------|-------------|-----------------|
| BEB-INFINI      | 2106 0682   | <b>INOX</b>     |
| BE-BEB-INFINI-B | 2106 0682-B | <b>RAL 9010</b> |
| BE-BEB-INFINI-G | 2106 0682-G | <b>RAL 7045</b> |
| BE-BEB-INFINI-N | 2106 0682-N | <b>RAL 9005</b> |